

taylordolman

keep living

PRESSALIT®
care



MATRIX – perfect
wash basins for any situation

taylordolman tel: 0845 838 0600 email: info@taylordolman.com

MATRIX

An evolution is underway

How do you go about creating the perfect wash basin? How do you develop something ideal? At Pressalit we have taken up this challenge. We have sought to create the perfect wash basin for people with special needs. We have therefore considered every aspect from the ground up: material, surface, design and function.

The perfect wash basin can be used both in the home and more demanding care environments, and provides support without compromising safety. The perfect wash basin is flexible and height adjustable, easy to clean and attractive to look at.

We have created several wash basins which fit this description and have grouped them in the MATRIX series, which offers four variants:

MATRIX Small – a narrow wash basin with two integrated handrails, designed for compact rooms where space is critical.

MATRIX Large – a wide vanity wash basin with integrated handrails at the front and sides, designed for rooms with more space.

MATRIX Angle – an attractive curved vanity wash basin with integrated handrails. It can be installed in corners or centred on walls. A large decorative vanity wash basin which also provides plenty of room to manoeuvre.

MATRIX Curve – a wash basin with a more conventional soft shape, without handrails.

keep living



Contents

MATRIX SMALL Elegance where space is limited	4
MATRIX LARGE Luxuriously spacious	8
MATRIX ANGLE Curved front and oval basin	12
MATRIX CURVE Rounded shapes and compact design	16
Dimensions and information	20
Wash basin brackets and supports	22
Accessories	24
Flexible feed and waste systems	26
Testing	27
Compatibility and material properties	30

MATRIX SMALL

Elegance where space is limited

The MATRIX Small wash basin has two integrated handrails in the front. It is ideal for bathrooms where space is limited but there is still a need for a solid, practical wash basin. The two handrails can be used as supports when the user has to stand up at the wash basin or turn around in

a wheelchair. The handrails may also be used as towel holders. The wash basin is designed with a shallow basin, leaving enough space for a wheelchair user to manoeuvre under the wash basin and reach the tap without difficulty.



MATRIX Small – a narrow wash basin with two integrated handrails, designed for compact rooms where space is critical.



The attractive handrails integrated into the wash basin are hygienic because their rounded shapes are easy to clean. They are also safe for daily use as they have been tested with a constant load of 200 kg for one hour – far exceeding the market standard.

The MATRIX Small wash basin is ideally suited for installation on the Pressalit Care SELECT R4950 wash basin lifter as shown. This makes the wash basin electrically height-adjustable, offering great flexibility.





MATRIX Large – a wide vanity wash basin with integrated handrails at the front and sides, designed for rooms with more space.

Like MATRIX Small, MATRIX Large has a striking and characteristic feature – the handrails cast into the tough marble.

The handrails are designed to give support when the user has to stand or sit down at the wash basin. This helps make the user more independent.

We guarantee its safety, even under heavy loads, as the handrails have been tested under extreme conditions. For more information about the handrail testing, see page 29.

MATRIX LARGE

Luxuriously spacious

The MATRIX Large vanity wash basin has four integrated handrails: two at the sides and two at the front. The vanity wash basin is designed to slope linearly towards the drain outlet, resulting in a modern and elegant expression while also ensuring that water drains quickly from the vanity

wash basin. The vanity wash basin is relatively flat in relation to its size, making it possible for a wheelchair user to manoeuvre right under it and get comfortably close to the tap.





MATRIX Large and MATRIX Angle feature large areas for all the practical items people use in a bathroom – or which make the room more attractive and inviting.

The surface and underside of the wash basins have been treated with a high-gloss, non-porous sanitation coating which is hard wearing and retains its attractive shine. Round corners and one-piece casting minimises bacteria growth on all surfaces – including the underneath.



MATRIX ANGLE

Curved front and oval basin

MATRIX Angle has an unusual curved front edge which provides maximum freedom of movement around the wash basin for users, helpers and cleaning staff. Its special shape makes the vanity wash basin ideal for installation in a corner, and it is therefore available as either a right or left-facing version. However, the vanity wash basin is also suitable for installation along a wall,

especially where space is limited and the user needs to get around in a wheelchair. The extra long handrails make it possible for wheelchair users to move around horizontally and rise to a standing position with maximum safety and support. The vanity wash basin also has a front drip tray to prevent water dripping onto the user.





MATRIX Angle – an attractive curved vanity wash basin with integrated handrails. It can be installed in corners or centred on walls. A large decorative vanity wash basin which also provides plenty of room to manoeuvre.

The MATRIX Angle vanity wash basin can be installed on height adjustable supports, so it can be adapted to the needs of the user and carer as much as possible.

Like the other wash basins in the MATRIX series, MATRIX Angle is characterised by an eye for detail. Above all, the wash basins are easy to clean. Every recess and corner has been designed for quick and thorough cleaning, by a simple wipe with a cloth.



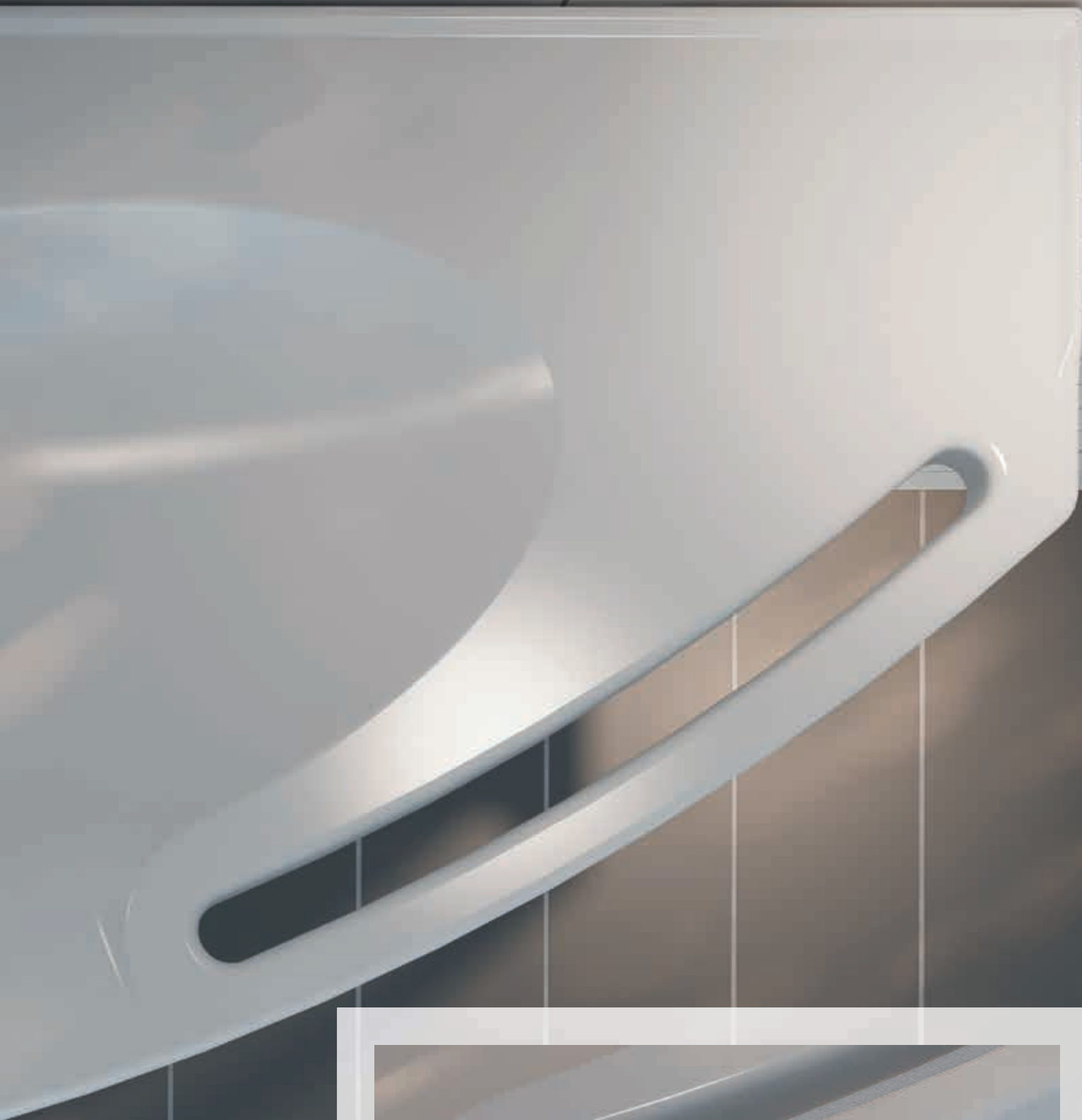

The length of the handrails makes it safe and easy for the user to move around the wash basin.

MATRIX Curve – a wash basin with a more conventional soft shape, without handrails.

MATRIX Curve and the other wash basins in Pressalit Care's product range are the result of the natural development of our primary value:

That people with physical limitations should be able to live as normal a life as possible without limitations. We also wish to create a better working environment for healthcare personnel and anyone else who comes into regular contact with our products.

Finally, we want to offer optimal choices to managers, architects and engineers responsible for choosing the products users and employees are surrounded by. The MATRIX series is a major step towards a complete product range for users with special needs.



MATRIX CURVE

Rounded shapes and compact design

MATRIX Curve is an ergonomic wash basin without handrails, suitable for fixed mounting on a wall or on Pressalit Care's wide range of wash basin lifters and brackets. It is available with or without an overflow.

It is ideal in situations where consideration must be given to space and the user's and helper's daily ergonomics, as it has a compact size and rounded edges.





The MATRIX Curve wash basin is ideally suited for installation on the Pressalit Care PLUS R4650 wash basin bracket as shown. This makes the wash basin electrically height adjustable, offering great flexibility.



Dimensions and information



MATRIX Small

R2020000

Wash basin with handrails and overflow

◀ **R2021000**

Wash basin with handrails, without overflow

Material:

Crushed marble with a high-gloss, non-porous sanitation coating.

Mounting:

Bolt mounted. Suitable for the PLUS and COMFORT series wash basin brackets and SELECT wash basin lifters.

Maximum load: 200 kg.



MATRIX Large

R2030000

Vanity wash basin, with handrails and overflow

◀ **R2031000**

Vanity wash basin, with handrails, without overflow

Material:

Crushed marble with a high-gloss, non-porous sanitation coating.

Mounting:

Bolt mounted. Suitable for height-adjustable and fixed supports.

Maximum load: 200 kg.



MATRIX Angle

R2040000

Angled vanity wash basin with handrails and overflow, right-facing

◀ **R2041000**

Angled vanity wash basin with handrails, without overflow, right-facing

R2042000

Angled vanity wash basin with handrails and overflow, left-facing

R2043000

Angled vanity wash basin with handrails, without overflow, left-facing

Material:

Crushed marble with a high-gloss, non-porous sanitation coating.

Mounting:

Bolt mounted. Suitable for height-adjustable and fixed supports.

Maximum load: 200 kg.



MATRIX Curve

◀ **R2050000**

Ergonomic wash basin with overflow

R2051000

Ergonomic wash basin without overflow

The concave front edge stabilises standing as well as seated users.

The rounded edges are also comfortable to hold and rest against.

Material:

Porcelain.

Mounting:

Bolt mounted. Suitable for the PLUS and COMFORT series wash basin brackets and SELECT wash basin lifters.

Maximum load: 200 kg.

MATRIX Small is a narrow wash basin with two integrated handrails in the front. The wash basin has a flat bottom, leaving room for the user's legs underneath. It is ideal for bathrooms where the available space has to be efficiently utilised.

The wash basin has raised edges, preventing water from running over the back or sides of the wash basin.

Tap hole: Ø 36 mm

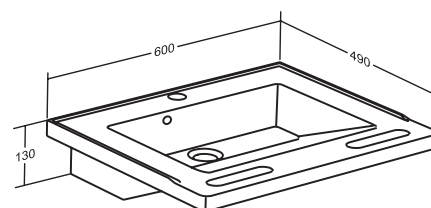

MATRIX Large is a vanity wash basin designed for bathrooms with plenty of space. The wash basin has two integrated handrails on the front edge and two handrails at the sides.

The wash basin has a flat bottom, allowing wheelchair users to manoeuvre right underneath. The wash basin has raised edges, preventing water from running over the back or sides of the wash basin.

Tap hole: Ø 36 mm

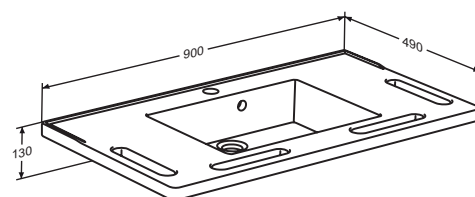

MATRIX Angle is designed so the wash basin can be positioned close to the toilet, while leaving a spacious work area for a helper. The vanity wash basin has two integrated handrails in the front. The wash basin has a front drip tray to prevent water dripping onto the user. The vanity wash basin's raised edges, also preventing water from running over the back or sides of the vanity wash basin.

The tap hole may be positioned asymmetrically as desired. Contact Pressalit Care for further details.

Tap hole: Ø 36 mm

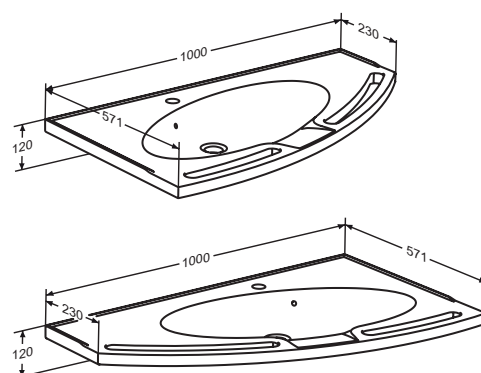

For seated users, the design of the corners provides space and support for the elbows at the wash basin, and the flat bottom leaves room for the legs underneath.

Tap hole: Ø 35 mm

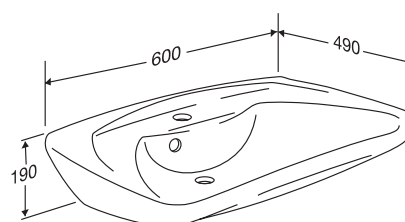

Wash basin bracket – PLUS and COMFORT

PLUS – height-adjustable wash basin brackets for horizontal wall track



- ◀ **R4782** Electric wash basin bracket with cordless remote control
- R4781** Electric wash basin bracket with wired hand control
- R4780** Electric wash basin bracket with lever control
- R4680** Gas operated wash basin bracket with lever control

Wash basin bracket for MATRIX Small and MATRIX Curve.

If the horizontal wall track is mounted at the recommended height, the wash basin is height adjustable over a range of 300 mm, from 668 to 968 mm above the floor.

Used with the horizontal wall track from the Pressalit Care PLUS series.

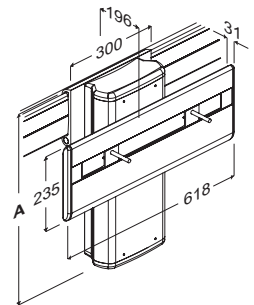

PLUS – height-adjustable wash basin bracket for horizontal wall track



- R4580** Manually adjustable wash basin bracket with lever control

Wash basin bracket for MATRIX Small and MATRIX Curve.

If the horizontal wall track is mounted at the recommended height, the wash basin is height adjustable over a range of 240 mm, from 680 to 920 mm above the floor.

Used with the horizontal wall track from the Pressalit Care PLUS series.

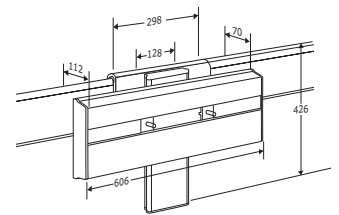

PLUS – height-adjustable wash basin bracket



- R4550** Manually operated wash basin bracket with lever control

Wash basin bracket for MATRIX Small and MATRIX Curve.

If the wash basin bracket is mounted at the recommended height, the wash basin is height adjustable over a range of 240 mm, from 728 to 968 mm above the floor.

Used with the Pressalit Care PLUS series.

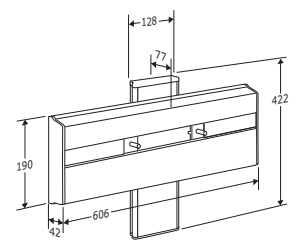

PLUS / COMFORT – height-adjustable wash basin brackets



- R4752** Electric wash basin bracket with cordless remote control
- R4751** Electric wash basin bracket with wired hand control
- R4750** Electric wash basin bracket with lever control
- R4650** Gas operated wash basin bracket with lever control

Wash basin bracket for MATRIX Small and MATRIX Curve.

If the wash basin bracket is installed at the recommended height, the wash basin is height adjustable over a range of 300 mm, from 668 to 968 mm above the floor.

Used with the Pressalit Care PLUS and COMFORT series.

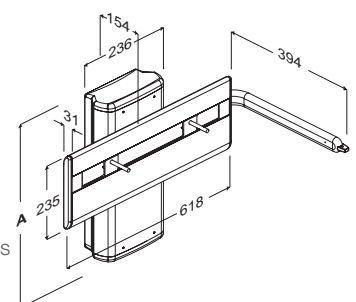

Materials: Aluminium, powder coated stainless steel, synthetic and plastic PS
Max. load: Wash basin brackets PLUS and COMFORT: 100 kg. SELECT: 150 kg. Brackets: 150 kg.

Wash basin brackets – SELECT and supports

SELECT – powered wash basin lifter

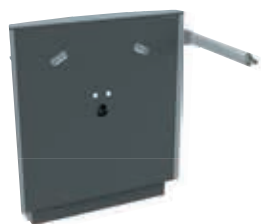

R4950xxx 300 mm height adjustable with electric motor and lever control

Wash basin lifter for MATRIX Small and MATRIX Curve.

The height of the wash basin can be adjusted 300 mm, from 670 to 970 mm above the floor, simply using a lever control.

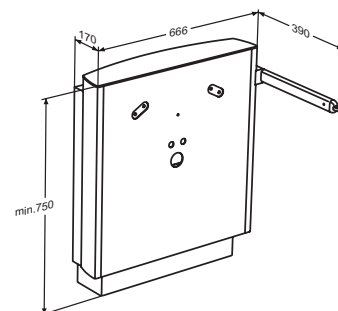

SELECT – powered wash basin lifter



R4951xxx 300 mm height adjustable with electric motor and wired hand control

Wash basin lifter for MATRIX Small and MATRIX Curve.

The height of the wash basin can be adjusted 300 mm, from 670 to 970 mm above the floor, simply using the user-friendly wired remote control.

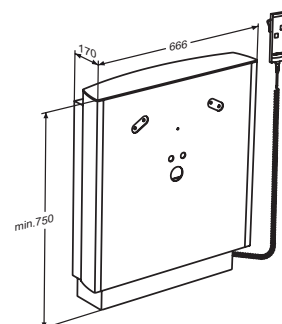

Manually adjustable wash basin brackets



R2015 Manually adjustable wash basin brackets, set of 2 pcs

Manually adjustable brackets for MATRIX Large and MATRIX Angle.

If the supports are mounted at the recommended height, the wash basin can be adjusted 200 mm, from 700 to 900 mm above the floor.

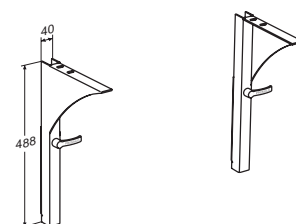

Fixed wash basin brackets



R2010 Fixed wash basin brackets, set of 2 pcs

Wash basin brackets for MATRIX Large and MATRIX Angle.



Colour:

xxx = cover plate colour

○ 000 White ● 112 Anthracite grey ● 227 Lime green

Accessories

Wash basin tap



RT622 Tap, long rotatable spout

The ring-shaped operating lever is suitable for disabled users. The long rotatable spout makes it easier for seated users to reach the water and the spout can always be pushed to one side, if it is in the way.

VA-approved (Denmark).

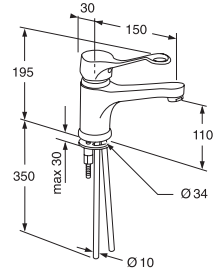

Wash basin tap



RT631 Tap with sensor

The tap with sensor is simple to install as it is battery powered (6 Volt). The battery has a life of 4-5 years. Infrared sensor technology makes the tap very user-friendly. The water temperature is set on the side of the faucet.

A tap with sensor helps improve hygiene, as it is not necessary to touch the tap in order to turn on the water. The risk of transferring bacteria is thereby reduced.

VA approved (Denmark).

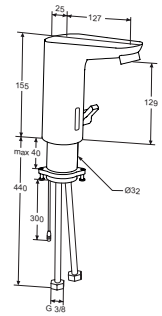

Mirror fittings and towel hooks



- ◀ **RT943** Hooks, 2 pcs
- ◀ **RT922** Mirror fittings, 4 pcs
- RT923** Mirror, 1000 x 600 mm
- RT924** Mirror incl. 4 mirror fittings

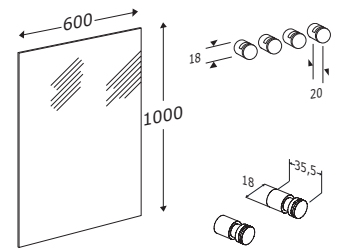

Water trap and air relief kit

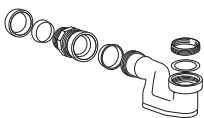

R2058 Water trap

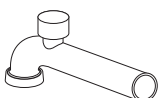

R2059 Air relief kit

Materials: Chrome-plated brass, plastic

Modular shelves for mounting on wash basin bracket



- ▶ **RT481** 600 mm rod, 2 shelves, towel holder, 2 trays
- ▶ **RT480** 400 mm rod, 1 shelf, towel holder, 1 tray

Modular shelves mounted on a wash basin bracket will move up and down and sideways with the basin.

Maximum load: 4 kg.

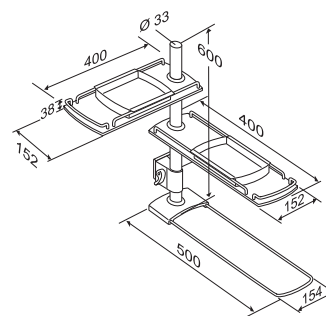

Fixed modular shelves



- ▶ **RT49100** 600 mm rod, 2 shelves, towel holder, 2 trays
- ▶ **RT49000** 400 mm rod, 1 shelf, towel holder, 1 tray

The basket, RT765, fits into the towel holder on the modular shelves. It is easy to carry into e.g. a hospital ward, enabling each patient to bring their own personal care articles.

Maximum load: 4 kg.

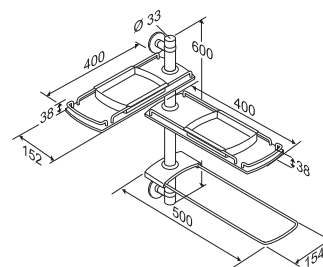

Basket and tray

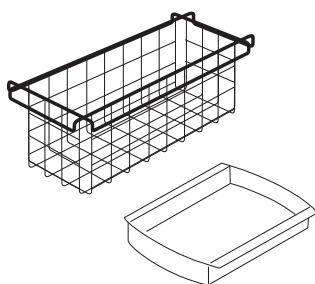

- ▶ **RT765** Universal basket, 326 x 116 x 136 mm
- ▶ **RT440000** Tray for shelf, towel holder and universal shelf, 180 x 130 x 36 mm

Installation covers

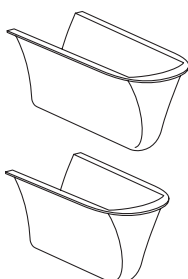

- ▶ **R2056** Suitable for wash basin R2050 and R2051
- ▶ **R2057** Suitable for wash basin R2020 and R2021

Accessories – flexible feed and waste systems



The flexible feed/waste systems are necessary to allow the wash basin height to be adjusted. To maximise product flexibility, it is important that the plumbing installations are correctly positioned and do not obstruct movement. Detailed mounting instructions are, of course, supplied with the individual products, but they can also be requested separately, e.g. for planning purposes.

R2061, R2062, R2064 and R2065 are VA-approved (DK), have 3/8" hoses and are used on all markets except the UK.

R2071, R2073, R2074, R2075 have 1/2" supply hoses and are primarily sold in the UK.

The feed and waste systems can be supplied to order in custom dimensions.

The installation height is matched to the wheelchair foot supports, etc.

Flexible feed and waste systems can be supplemented by:

Water trap: R2059

Air relief kit: R2059

Pressalit Care recommends that isolating valves on the feed connections and waste wall connections are at 90° angles, pointing downwards.

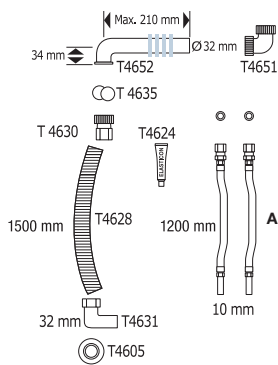

Flexible feed and waste system, 1200 mm

R2064: A = T4626

R2074: A = T4633

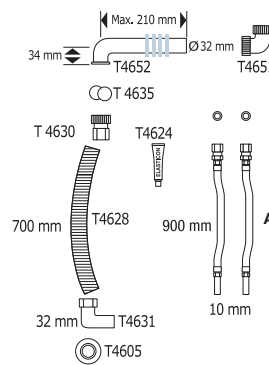

Flexible feed and waste system, 900 mm

R2062: A = T4627

R2073: A = T4611

Only used with SELECT wash basin lifters

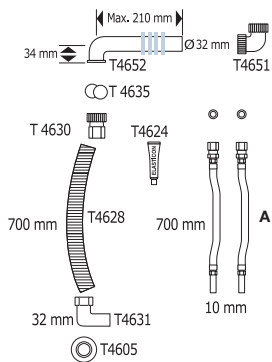

Flexible feed and waste system, 700 mm

R2065: A = T4627

R2075: A = T4611

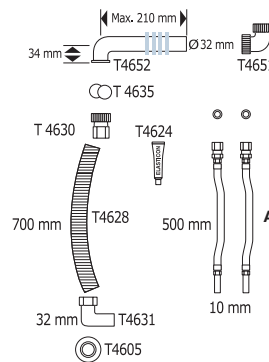

Flexible feed and waste system, 500 mm

R2061: A = T4604

R2071: A = T4610

Extreme testing provides extreme confidence

With our MATRIX wash basin series we have done what we thought had to be done: We have considered the user. We have considered the helper. And we have considered the room the wash basin is required to function in. In other words, we have thought about every aspect of the usage situation from the ground up.

A wash basin has to be able to withstand more than you might realise, especially when used by people with special needs.

In everyday use, users often need support from the wash basin in order to simply stand up. The wash basin must be able to handle this. That is why we carry out thorough, uncompromising, almost extreme testing. The security we build into our products must be completely without reservation.

LOAD – in the right place



When we test a product like a wash basin, we naturally do so at the most sensitive place – where the load is greatest. This is at the front edge of the wash basin, so this is what we focus on.

We test at the point which results in the greatest static torque, and we test repeatedly until we are satisfied. The wash basins are tested with repeated loads which far exceed what they will be subjected to in the real world. This is the security we always build into our products.



Incredibly strong wash basins

The brackets and the wash basin material must be able to withstand very high loads without showing any negative side effects. As a minimum, wash basins must fulfil BS/EN 14688 – and ideally exceed it. We have therefore tested the MATRIX wash basins with a high static load – up to 200 kg for one hour.

MATRIX wash basins are tested precisely where the pressure is greatest during daily use – at the front edge and in the centre above the drain hole. The wash basins have passed all tests without showing the slightest sign of damage.

Handrails with maximum safety

The MATRIX Small, MATRIX Large and MATRIX Angle wash basins from Pressalit Care have practical and attractively designed handrails integrated directly into the wash basin. Users must be able to support themselves using the handrails and use them to pull themselves up into a standing position. This places great demands on the material.

No standards have yet been defined for the strength of this type of handrail. We have therefore defined our own very strict requirements. We conducted two types of tests on the hand rails and our various wash basin models – and they all passed both tests with flying colours.

Lateral load

In one test rig we carried out a dynamic test of the handrails under a lateral load of 100, 125 and 150 kg (20 loads of one minute's duration, separated by rests of 10 seconds).

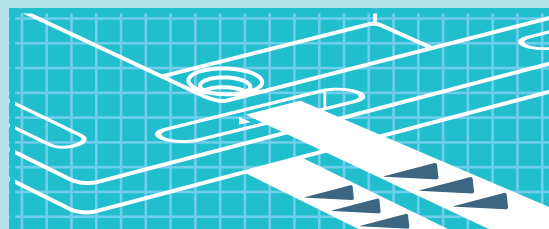

Vertical load

The handrails have also been subjected to a static test with a maximum vertical load of up to 200 kg for one hour. This was followed by a dynamic test with a vertical load of 100, 125, 150, 175 and 200 kg (20 loads of one minute's duration, separated by rests of 10 seconds).



Compatibility and material properties

Compatibility

	PLUS	SELECT	COMFORT	VALUE
MATRIX Small wash basin	●	●	●	
MATRIX Large vanity wash basin				
MATRIX Angle vanity wash basin – right-facing				
MATRIX Angle vanity wash basin – left-facing				
MATRIX Curve Ergonomic wash basin	●	●	●	●

Supports/ mounting

	Fixed supports	Height adjustable supports	Bolt mounted
MATRIX Small wash basin			●
MATRIX Large wash basin	●	●	●
MATRIX Angle wash basin – right	●	●	
MATRIX Angle wash basin – left	●	●	
MATRIX Curve Ergonomic wash basin			●

Specifications

	Tap hole	Load
MATRIX Small wash basin	Ø 36	200 kg
MATRIX Large vanity wash basin	Ø 36	200 kg
MATRIX Angle vanity wash basin – right-facing	Ø 36	200 kg
MATRIX Angle vanity wash basin – left-facing	Ø 36	200 kg
MATRIX Curve Ergonomic wash basin	Ø 35	200 kg

Materials

	80% crushed marble / 20% synthetic*	Porcelain	High-gloss polished non-porous sanitation coating
MATRIX Small wash basin	●		●
MATRIX Large vanity wash basin	●		●
MATRIX Angle vanity wash basin – right-facing	●		●
MATRIX Angle vanity wash basin – left-facing	●		●
MATRIX Curve Ergonomic wash basin		●	

*) Strong material with a surface which is pleasant to the touch.

Cleaning instructions

	Crushed marble	Porcelain
Calcium remover	Very good/suitable	Very good/suitable
Acidic products (lemon, vinegar, etc.)	Very good/suitable	Not suitable*
Chemical residues following normal bathroom use	Very good/suitable	Not suitable
Hard-wearing surface	Less good	Very good/suitable
Resistant to scratching	Less good	Good
Surface may be polished	Less good	Not suitable
Surface may be repaired	Very good/suitable	Not suitable
Hygienic surface	Very good/suitable	Very good/suitable
Easy to maintain	Good	Good
Cleaning using fibre cloth	Very good/suitable	Very good/suitable
Cleaning using scourer	Not suitable	Not suitable
Suitable for kitchens	Not suitable	Not suitable

The above properties depend on the wash basins being cared for in accordance with Pressalit's mounting and maintenance instructions. If you wish to retain the attractive surface we recommend you avoid cleaning agents which are abrasive or contain chlorine.

*) Only acetic acid and calcium removing agents which are rinsed off using water immediately after application.

PRESSALIT® CARE

Reduced functionality need not limit a person's development. For more than 35 years, the keep living philosophy has been a guiding principle for Pressalit Care's development of flexible kitchen and bathroom solutions for people with disabilities.

Thanks to its research-based knowledge, Pressalit Care is a market leader within specialist kitchen and bathroom solutions and today provides consultancy to customers worldwide.

An underlying respect for the individual and his or her possibilities is also reflected in the company's relationship to society at large and the local community. At Pressalit, Corporate Social Responsibility (CSR) is deeply rooted in the company's strategy and values and guides all parts of the organisation

Pressalit Care's head office is located in Denmark.

www.pressalit.com



taylordolman

tel: 0845 838 0600

email: info@taylordolman.com

www.taylordolman.com