

taylordolman

molift[®]

SMART 150



CE

BM09201 Molift SMART 150 English - Rev E 10/2012

molift[®]
by Etac

OPERATOR MANUAL

Table of content

About Molift Smart.....3
Before using the patient lifter 3
Explanation of symbols 3

General Safety precautions4
General 4
Lift and transfer 4

Assembly / disassembly5
Unpacking 5
Assembly..... 5
Disassembly..... 6
Storage..... 6

Molift Smart 150 - use7

Checklist before use7

Lift and transfer8
Use of spread legs 8

Safety devices9
Emergency stop and lowering..... 9

Operation 10
Battery charger..... 10
Battery capacity..... 10
Electronics..... 10

Technical data 11
Labelling..... 12

Accessories 13
Lifting sling 13

Equipment..... 14
Transport bag 14

Troubleshooting 15

Maintenance 16
Cleaning 16
Monthly inspection 16
Periodic inspection 16
Service 17
Checklist periodic inspection..... 18
CE declaration..... 19

IMPORTANT!

The patient lifter is only meant to be used by qualified personnel.
 The manual shall not be handed over, or made available to, any unauthorised third party, without a prior written consent from Etac Supply Gjøvik. Existing laws, conventions and agreements protects all documents. No extract of this documentation can be reproduced, used or transferred without prior written consent from Etac Supply Gjøvik. Violation of these regulations may lead to judicial repercussions and economic responsibility. Industrial rights are reserved.



Etac AS, Etac Supply Gjøvik

Hadelandsveien 2
 2816 Gjøvik, Norway
 Teleph: (+47) 40001004 www.molift.com
 Fax: (+47) 40001008 molift@etac.com

About Molift Smart 150

Molift Smart 150 is a foldable mobile lifter intended for lifting and transferring personnel to/ from bed, chair, wheelchair and toilet. The lifter is made out of light materials, it has castors and a battery and a lifting capacity of 150 kg . It is therefore ideal for mobile care units, such as home care personnel who has a need for lifting capabilities without fixed or stationary lifting devices present in every home. Molift Smart 150 can also be used in hospitals and institutions. The lifter should only be used for transfers across short distances, such as between a chair and a bed or into bathroom/restroom and cannot replace a wheelchair or similar.

The Molift Smart 150 with accessories as described in this manual are CE marked according to the Council Directive concerning medical devices (93/42/EEC). The lifter is classified as medical equipment class 1, and tested and verified by a third party, according to standards IEC 60601-1, IEC 60601-1-2 and NS-EN ISO 10535:2006

Before using the patient lifter

Before using a patient lifter, the operator must be trained accordingly. Practice lifting a colleague, and be lifted by others. It is important not only to know how to move another person using the lifter, but also how it is to be lifted. Try out and practice using all the relevant slings for the different types of lifter and movement you may encounter. Before lifting a person, you should explain the procedure. When using the lifter, it's also important to use the correct sling and accessories according to:

- type of disability
- size
- weight
- type of movement



The lifter must be taken out of service immediately, or not returned to service, if faults and/or irregularities that may have influence on the safety are discovered.

Explanation of symbols



This symbol is used to point out instructions and information related to work place safety where injury may occur if the information is disregarded or ignored. Follow these instructions, be careful and attentive at all times.



This symbol indicates important and useful information. If taken into consideration, it will help the operator of the lifter to work efficiently. It may help simplify routines and to explain complicated facts.




General Safety precautions

General

Before putting a Molift Smart 150 into operation, the operator must ensure that the lifter and accessories are in good working order, especially with regards to safety.

A Molift Smart 150 shall only be used when all safety devices and equipment is in place and fully operational.


The lifter must be taken out of service immediately, or not returned to service, if faults and/or irregularities that may have influence on the safety are discovered.


 *The lifter has an expected lifetime of 10 years or 30 000 lifts with max load (SWL), when all recommended service is performed.*


Injury to personnel or equipment may occur if Molift Smart 150 is used in an incorrect manner and if i.e:


- covers are removed by unauthorised personnel
- used incorrectly
- insufficient maintenance
- load exceeds maximum limit. The maximum load stated in this manual and on the lifter is the maximum load
- unauthorised repair of electrical devices or cables


Lift and transfer


 *The Molift Smart 150 has a Safe Working Load on 150 kg, meaning that it is tested and approved for lifting of patients up to 150 kg. Attempts to lift patients above SWL may damage the lifter and lead to personal injury.*


 *The patient lifter may tip over if used incorrectly! Ignorance of warnings and instructions may lead to personnel injury. Read instructions carefully before attempting to lift anyone.*


 *Pay close attention to your actions. Ensure that all four loops of the sling are securely fastened to avoid the user slipping or falling*

 *Use the push handle to manoeuvre the lift, do NOT attempt to manoeuvre the lift by pushing on the lifting arm, actuator or patient.*


 *Torn, cut, frayed or broken slings can fail, resulting in serious injury to the user. Use slings in good condition only. Destroy and discard old, unusable slings.*

 *Molift slings shall ONLY be used to lift persons. NEVER use the sling to lift and/or move objects of any kind.*

 *Molift Smart 150 should not be run constantly for more than 2 minutes (with maximum load), and rest for minimum 18 minutes.*

 *If the lifting movement does not start when the corresponding button is pressed, please consult the fault finding table in the maintenance chapter to locate the fault.*

Several factors have to be considered during movement of the lifter. Stand to the side of the user when lifting. Ensure that arms and legs are clear of the lift, chair, bed etc. Try to maintain eye contact with the user - this will help the user feel safe and comfortable.

 *Medical electrical equipment requires special precautions regarding electromagnetic compatibility (EMC) and must be installed and used according to instructions contained in this manual. Portable or mobile radio communication equipment may affect the medical electrical equipment, and should be kept minimum 25 cm from the lifter electronics..*

Assembly / disassembly

Unpacking

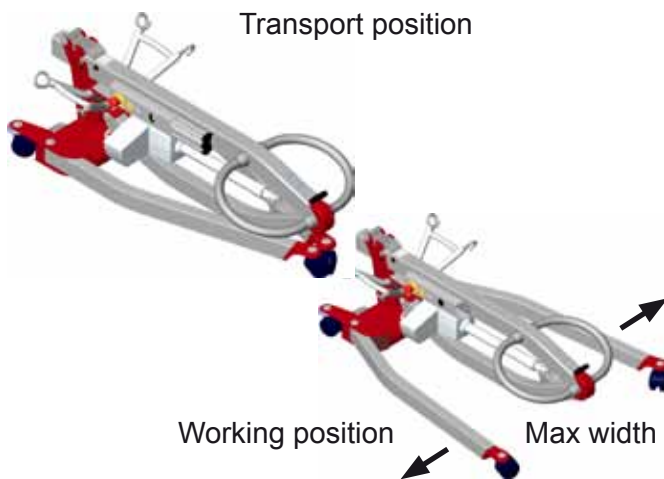
- The lifter comes in one cardboard box. Verify that the box has no apparent damage. If damaged, check the content and contact your dealer for assistance if components are damaged.
- The box contains one complete Molift Smart lifter with hand control, battery and battery charger.

Assembly



The battery must not be in the battery holder during assembly!

- Remove the transport elastic and spread the legs to working position (maximum width).



The legs must be spread to working position before the column can be mounted.

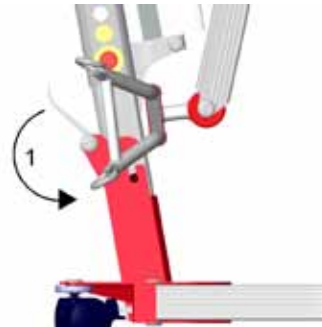
- Lift up the lifting column and slide it into the bracket on the chassis.



The column must be placed in the bottom of the bracket on chassis as shown on the illustration to the left.



- When the column has placed itself in the bottom of the bracket, it must be fixed with the locking handle on the back of the chassis. Push the locking handle down (1) and make sure the column is properly fixed.



- Lift the suspension out of the transport hook.



Do not start to run the lifting arm before the suspension is released!

- Insert the battery into the battery holder and verify that the emergency stop button isn't activated. Run the lifting arm up and down without load to verify that it is working properly.



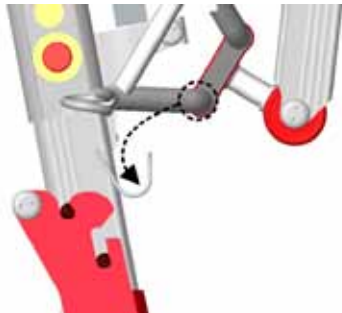
Check that the lifter is mounted correctly with no loose part or damages. Ensure that the lifting column is fixed properly, and that the legs do not move inside working position.

Checklist after mounting.

- Check the lifter according to the checklist before use on page 7.

Disassembly

- Run the lifting arm all the way down while holding the suspension up towards the lifting arm allowing the suspension to be placed into the transport hook.



- Remove the battery from the lifter to prevent it from falling out during transportation.

i The control electronics are active as long as the battery is placed in the holder. If the lifter is to be stored for a longer period, the battery should then be removed (or emergency stop activated) to avoid unnecessary discharge of the battery.

- Open the locking handle, lift up the lifting column (grab with both hands and lift straight up) and fold the column down to transport position.



i The lifter can be split into two parts by lifting the column from the chassis completely. The lifting column/-arm and the chassis with legs are then separate parts.

! Be careful not to get legs/arms/hands wedged between the parts when folding down the lifting column/-arm.

- Fasten the hand control to the driving handle
- Press the legs together and secure legs and lifting column/-arm with the transport elastic.
- Put the lifter into the bag.



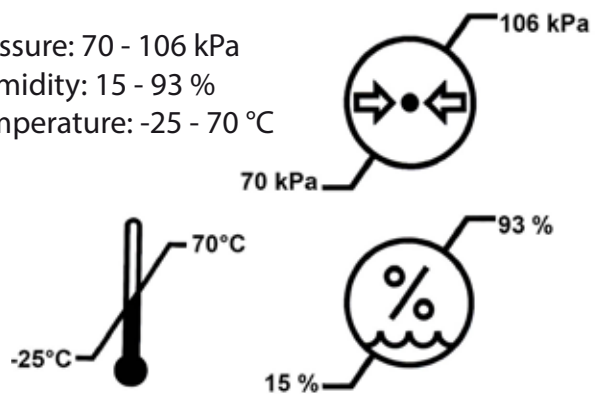
Storage

For long time storage it is recommended that the battery is removed and the emergency stop button is activated. The lifter can be stored and transported under the following conditions:

Pressure: 70 - 106 kPa

Humidity: 15 - 93 %

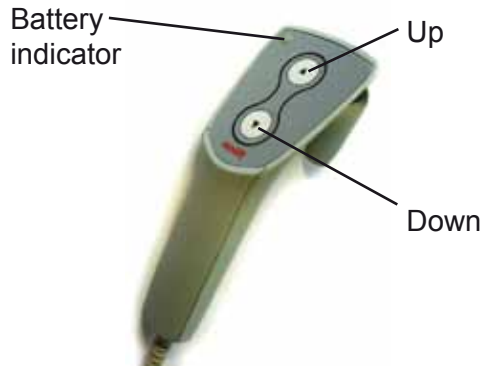
Temperature: -25 - 70 °C



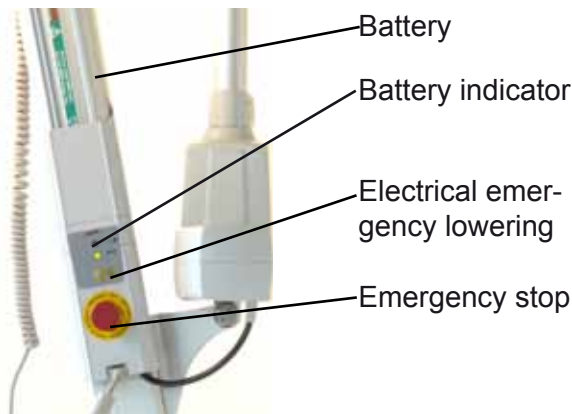
i The lifter is designed for use at standard room temperatures (+5 to +40°C). Following storage or transport at other temperatures leave the lifter in a room with a suitable temperature until it reaches a safe operating temperature.

Molift Smart 150 - use

The Molift Smart 150 hand control has two buttons (up and down). In addition there is a diode which gives a light if the battery needs charging.



The legs are adjusted with pedals on the chassis.

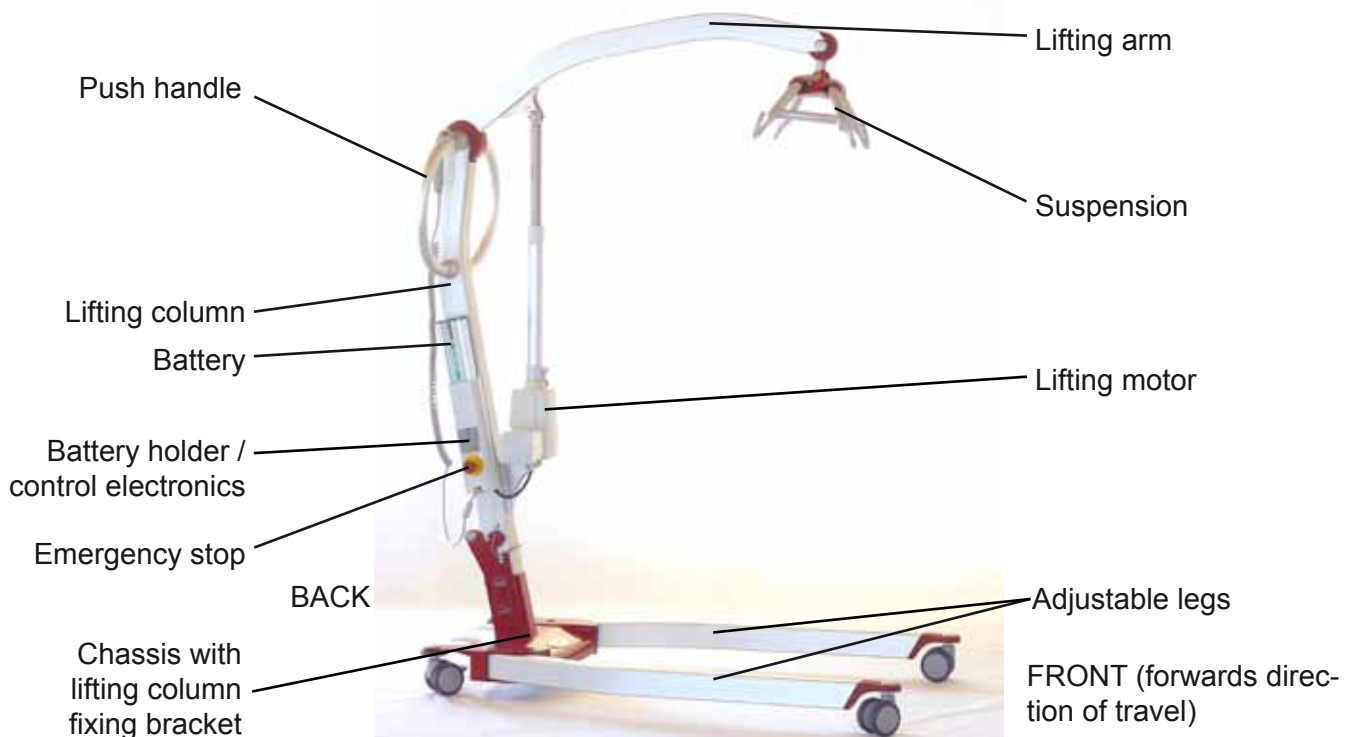


Checklist before use

1. Check that the lifter has no apparent damage or other faults.
2. Check that there are no loose parts, and ensure that the lifting column is properly fixed and that the locking handle is properly tightened.
3. Check that the legs are moving in working position only, meaning that the legs do not move inside working position with the column mounted (see fig A).
4. Check that the suspension is released from the transport hook.
5. Check that the emergency stop button is not activated and that the lifter is functioning.
6. Check that you have sufficiently charged batteries (that the battery diode on hand control or chassis does not light).
7. Check that the service lamp gives a green light. If yellow or red light, send lifter to service.
8. If there are any faults or irregularities, the lifter should be taken out of service immediately and marked "out of order". Contact your service partner or local Molift representative.

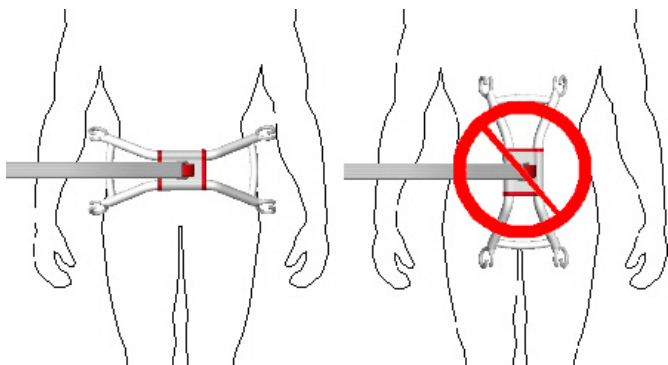



Fig A



Lift and transfer


The suspension shall always be positioned across the user as shown left in the illustration below.




 Check that the sling is properly fastened to all four hooks on the suspension to make sure the patient is not sliding or falling out

Try to position the user as low as possible (preferably resting the feet on the chassis) when transferring the lifter with a suspended user. In this way, the centre of gravity will be as low as possible and therefore reducing the risk of instability. The lifter should be manoeuvred with spread legs in outer position to achieve the highest possible stability.

Be careful during movement - the suspended user may swing somewhat during turns, stops and starts. Be particularly careful when manoeuvring close to furniture to prevent the suspended user from colliding with these objects.

 The lifter shall not be used to lift or move users on sloping surfaces.

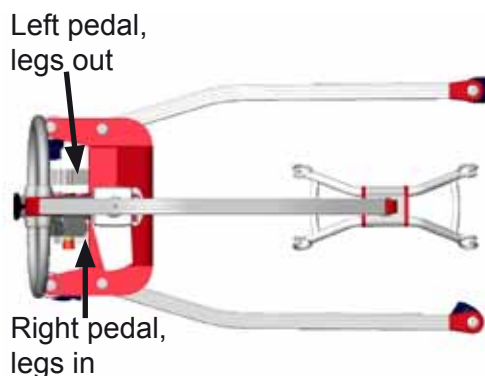
Avoid deep pile carpets, high thresholds, uneven surfaces or other obstacles that may block the castors. The lifter may become unstable if forced over such obstacles increasing the risk of tipping over.


 The lifter shall only be used for movement over short distances. It is not a replacement for wheelchair or similar.

Use of spread legs

Use wide legs wherever appropriate, for instance to position the lifter around wheelchairs, toilets etc.

- To spread the legs, press (pump) the left pedal on the chassis.
- To narrow the legs, press (pump) the right pedal.




 On carpet floors you might find it difficult to manoeuvre the legs with a patient in the lifter. It is recommended, if possible, to adjust the legs before suspending the patient in the lifter. Alternatively you might try to move the lifter at the same time as pressing the pedals for leg adjustment.

Safety devices

Molift Smart 150 is equipped with several safety devices, which are intended to prevent damage to personnel and equipment in the case of incorrect use.

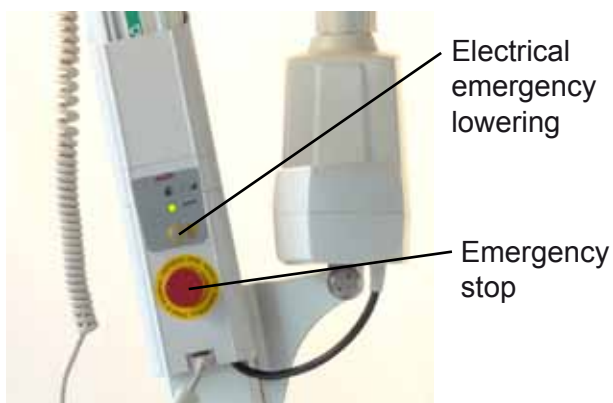
- The lifter has an overload sensor preventing the lifter to be operated with more the safe working load, 150 kg. If the load exceeds the SWL, the lifter will stop the movement.
- The lifter has a safety feature to prevent the lifting arm and suspension from squeezing a user if lowered too much. The actuator will not produce any force in downward movements.
- The legs are folded together during transport to make the lifter as small as possible. When assembling the lift, the legs must be spread to working position. A safety feature will prevent the lifting column to be fixed in the bracket before the legs are spread beyond transport position.
- The suspension has safety hooks to prevent the sling loops to fall off.
- The electronics are disabled if the temperature rises beyond a critical limit. Wait until the lifter has cooled down before using it again.

Emergency stop and lowering

 Contact your Molift service partner if the reason for the failure causing an emergency lowering is unknown or if it is a result of failed components or parts.

Emergency stop

The emergency stop will cut the power to the actuator, and is situated on the battery holder on the lifting column. Turning it clockwise until it pops out will reset the emergency button.



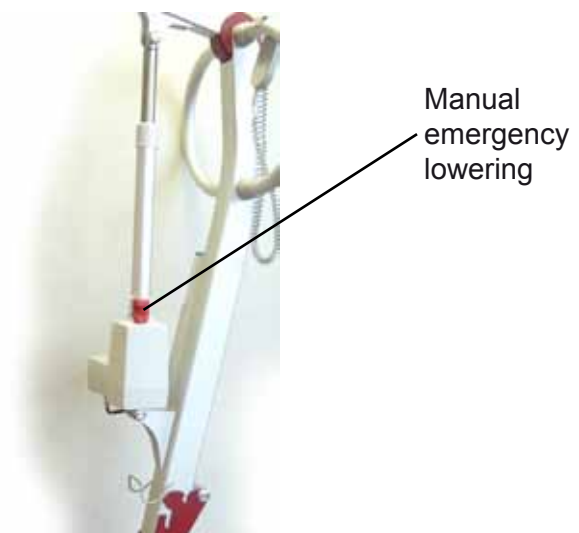
Electrical emergency lowering

It is possible to perform an emergency lowering of the lifting arm in case of a general malfunction of the control electronics. The button can be found on the battery holder. If you need to perform an emergency lowering, move the lifter to a suitable location to lower the user.

- Press the emergency lowering button. The lifting arm will then perform a smooth downward movement. The emergency stop button can not be activated when performing electrical emergency lowering.
- If the lifter still do not work, change battery and try the emergency lowering procedure again.
- If it still does not work, the suspended user must be lifted out manually either by using the manual lowering function or by requesting assistance.

Manually emergency lowering

The manually lowering function on the actuator is only to be used if the electrical lowering does not work.



Pull the red handle slightly upwards. Take care, the lifter moves faster when activating the handle more. The lifter will stop dead with a danger of personal injury and damage on the lifter if the handle is released suddenly.

Operation

Battery charger

Molift Smart 150 is supplied with a battery with a 14,4 V cell unit that is placed in the battery holder on the lift. A battery charger is also supplied to be located easily accessible, either stand-alone or mounted on the wall. Connect the charger mains cable to the wall socket when charging the battery.



Disconnect the charger mains cable when the charger is not used. Take care not to damage the cable.



Place the battery in the holder according to the arrow markings. After a few seconds the charger LED will change from yellow to orange, indicating that the battery is charging. When the LED gives a constant green light the battery is fully charged.

The charger LED indicate the status of the battery as described below:

LED	Mode
Yellow	No battery
Yellow	Initialization (10 sec)
Orange	Fast charge
Green/yellow	Top-off charge
Green	Trickle charge
Orange/green	Error

Battery capacity

The battery indicator on the hand control will illuminate if the voltage of the battery falls below a certain level, indicating the need for charging. There will also be an audible signal. There is still enough capacity to perform 3-5 lift cycles (75 kg) at this point. The battery indicator on the battery

holder illuminates only if the handcontrol unit is disconnected and the battery needs charging.



If the battery is discharged during a lift, it is always enough power to lower the user down again.



New batteries will not achieve full capacity before it has been fully charged and discharged a couple of times.



The battery lifetime is about 500 charging cycles.

Electronics



There is a counter implemented in the electronic system of the lifter, registering the number of lifts. This number can be read by using the Molift Servitool, and a service lamp indicates when the lifter needs service consisting of exchange of the lifting motor. See the chapter "Maintenance".

The electronic system has a power save-function which makes the system sleep after a while with no activity. All lights will go out. Activate the system by pushing one of the buttons on the hand control.

If the lifter is run up and down constantly for a longer period, the electronics may be overheated and the lifter will stop. Wait until the lifter is cooled down enough for further use.



Discarded lifters and batteries should be handled as electronic waste and collected separately according to local laws and regulations.

Technical data

Weight, total:

Ex. battery; 25 kg / incl. battery: 25,8 kg

Material:

Steel and aluminium

Motor:

12 VDC

Battery:

14,4 V NiMH 2,2 Ah, Molift Power Pac

Battery charger:

Mascot type 2215, 10-22 cells NiCd/NiMH

Protection:

IP24

Number of lifts with fully charged battery:

40 (75 kg/165 lb, 50 cm up/down)

Safe Working Load (SWL):

150 kg (330 lbs)

Lifting height:

0 - 750 mm below user

Lifting speed:

60 mm/sec

Sound level, max A-weighted sound power level:

$L_{WA} = 49,4$ dB

Operating forces:

Buttons on hand control: 1,5 N

Foot pedal: max 300 N

Height of legs:

Max 110 mm

Turning diameter:

1300 mm

Measurement, transport:

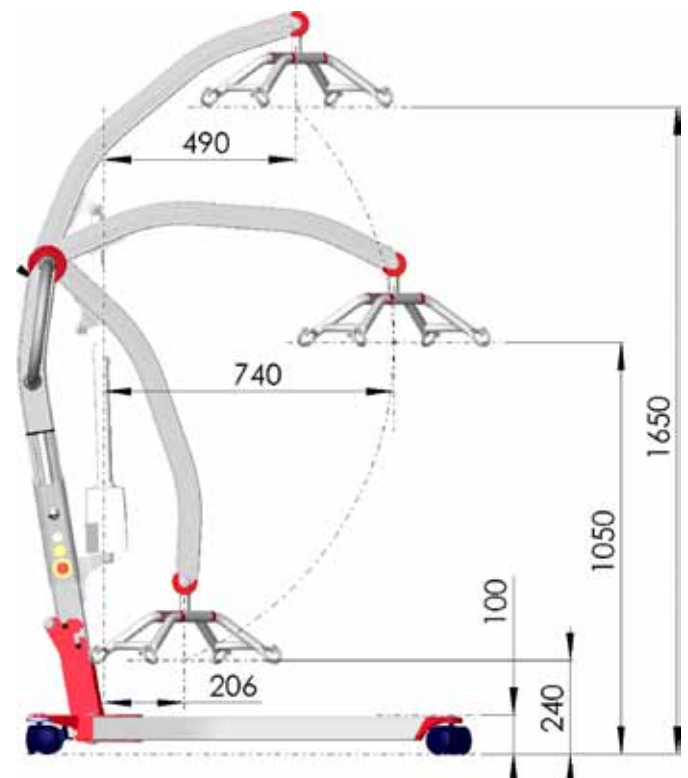
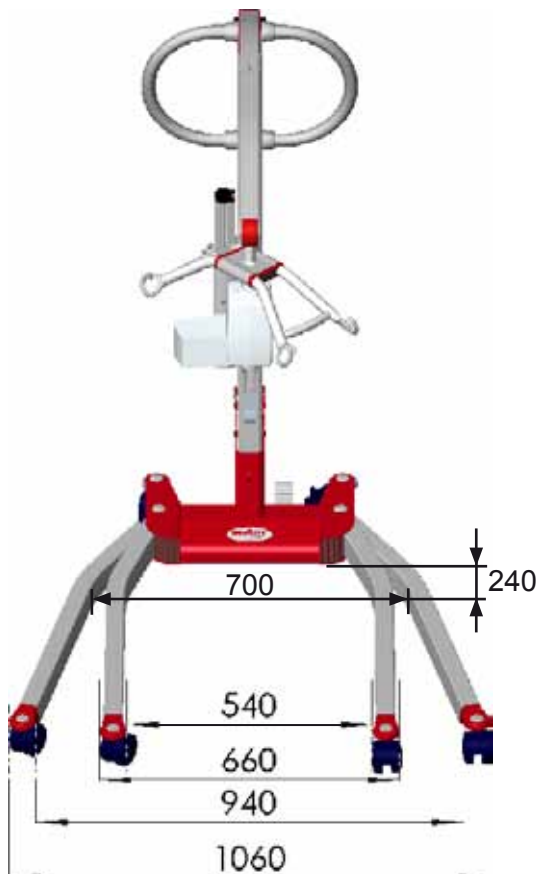
1160 x 475 x 355 mm (LxWxH)

Measurement, assembled:

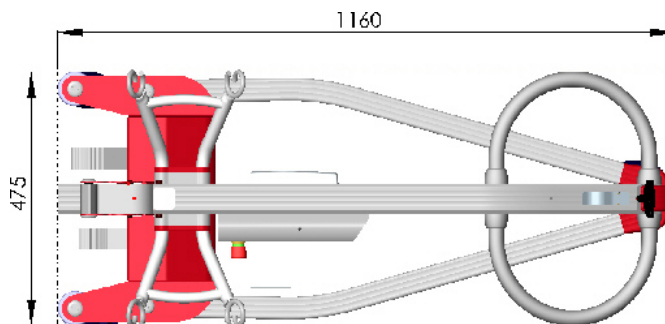
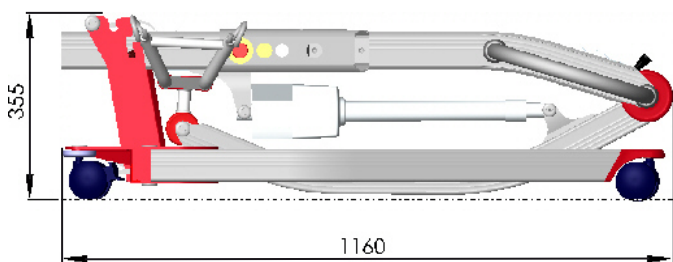
1160 x 1060 mm (LxW)

Measurements in illustrations below are in millimetres.

Measurements with lifter in working position



Measurements with lifter in transport position



Labelling

The main label is placed on the column bracket on the left side of the chassis.

Nominal battery voltage



Model name

Safe Working Load

Part number and year/week of manufacturing

Serial number / bar code

Manufacturer

Separate waste collection

For indoor use only

Read user manual

Type BF Application

Control label on right side on chassis



Control lifter according to checklist on page 18

Periodical inspection each 12 month

Designated area for calendar and signed label for periodical inspection

READ USER MANUAL!

Molift Smart 150 short guide for mounting

READ USER MANUAL!

Lifter in transport position

Spread legs

Raise the lifting column

Make sure the column is placed correct in bottom of the chassis

Close the locking handle to secure the column.

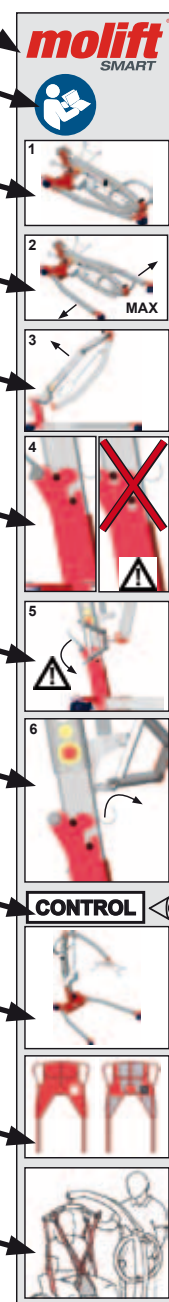
Release the suspension from transport hook.

Check lifter before use (checklist on page 7)

Lifter is ready for use

Choose correct sling and check for damage.

Make sure sling is attached correctly. Pay attention while lifting.



Accessories

Lifting sling

Molift Easy Paediatric Sling

Size	No head support	With head support
XXS	Art. no 3005050	Art. no 3006050
XS	Art. no 3005000	Art. no 3006000

Easy Toilet Sling and Basic Bathing Sling for kids, see the tables below, size XXS and XS.

Molift Easy Sling

Size	No head support	With head support
XS	Art. no 3025000	Art. no 3026000
S	Art. no 3025100	Art. no 3026100
M	Art. no 3025200	Art. no 3026200
L	Art. no 3025300	Art. no 3026300
XL	Art. no 3025400	Art. no 3026400
XXL	Art. no 3025500	Art. no 3026500

Molift Basic Sling

Size	No head support	With head support
XXS	Art. no 3021050	Art. no 3022050
XS	Art. no 3021000	Art. no 3022000
S	Art. no 3021100	Art. no 3022100
M	Art. no 3021200	Art. no 3022200
L	Art. no 3021300	Art. no 3022300
XL	Art. no 3021400	Art. no 3022400
XXL	Art. no 3021500	Art. no 3022500

Molift Basic Bathing Sling

Size	No head support	With head support
XXS	Art. no 3023050	Art. no 3024050
XS	Art. no 3023000	Art. no 3024000
S	Art. no 3023100	Art. no 3024100
M	Art. no 3023200	Art. no 3024200
L	Art. no 3023300	Art. no 3024300
XL	Art. no 3023400	Art. no 3024400
XXL	Art. no 3023500	Art. no 3024500

Molift FullSling

Size	With head support
S	Art. no 3047010
M	Art. no 3047011
L	Art. no 3047012

Molift Easy Toilet Sling

Size	No head support	With head support
XXS	Art. no 3032050	Art. no 3033050
XS	Art. no 3032000	Art. no 3033000
S	Art. no 3032100	Art. no 3033100
M	Art. no 3032200	Art. no 3033200
L	Art. no 3032300	Art. no 3033300
XL	Art. no 3032400	Art. no 3033400
XXL	Art. no 3032500	Art. no 3033500

Molift Easy Toilet Sling Comfort

Size	No head support	Separate head support
XXS	Art. no 3016050	Art. no 3016055
XS	Art. no 3016000	Art. no 3016001
S	Art. no 3016100	Art. no 3016111
M	Art. no 3016200	Art. no 3016222
L	Art. no 3016300	Art. no 3016333
XL	Art. no 3016400	Art. no 3016444
XXL	Art. no 3016500	Art. no 3016555

Molift Easy Amputee Sling

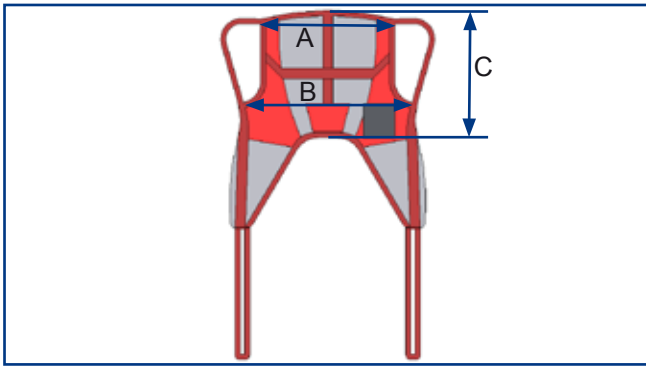
Size	No head support	With head support
XXS	Art. no 3027050	Art. no 3028050
XS	Art. no 3027000	Art. no 3028000
S	Art. no 3027100	Art. no 3028100
M	Art. no 3027200	Art. no 3028200
L	Art. no 3027300	Art. no 3028300
XL	Art. no 3027400	Art. no 3028400
XXL	Art. no 3027500	Art. no 3028500

Molift Patient Specific Sling

Size	With head support
S	Art. no 3050100
M	Art. no 3050200
L	Art. no 3050300
XL	Art. no 3050400

Bag for slings - Art. no 3048000

Sling size guide



Easy and Basic Slings

Size	Color code	Recomm. weight (Kg)	A (cm)	B (cm)	C (cm)
XXL	White	230-300	86	130	68
XL	Blue	160-240	76	115	66
L	Green	90-160	66	100	64
M	Yellow	45-95	56	85	62
S	Red	25-50	51	75	60
XS	Light blue	17-25	46	65	58
XXS	Pink	12-17	41	55	56

Choice of sling size depends on both user weight and shape/size of user.

i Please see the user manual that comes with the sling for specific instructions.

Equipment

Transport bag

for Molift Smart 150 lifter w/batteries.

- Transport bag (soft) for Molift Smart
Part. no: 3049175
- Hard case for Molift Smart
Part. no: 0920200

Troubleshooting

Faults on lifters that do not function as they should after assembly (page 5) or after the pre-use check has been completed (page 7), can be localized using the troubleshooting table below.

Symptom	Possible cause/action
The lifting column is wobbly	The lifting column is not correctly positioned in the chassis or the locking handle is not fully locked / <i>verify position of lifting column and locking handle acc. to mounting instructions on page 5.</i>
	The lifting column can not be correctly fitted / <i>faulty safety mechanism in chassis, contact local representative for service</i>
The lifter moves unevenly on a plane surface	The castors move unevenly because of pile and dust / <i>clean castors as described on page 16.</i>
	Fault in the leg spreading mechanism / <i>contact local representative for service.</i>
The lifter only moves in one direction - either up or down	Hand control has failed / <i>test with another hand control and change if defective.</i>
	The control electronics has failed / <i>contact local representative for service and use manually emergency lowering, where necessary</i>
The lifter runs out of control	Short circuit between hand control and lifter / <i>clean hand control plug surfaced with alcohol to remove grease</i>
	Defective hand control / <i>replace hand control / contact local representative for service</i>
	The control electronics has failed / <i>contact local representative for service</i>

Symptom	Possible cause/action
The lifting arm (lifting motor) does not move	Emergency stop button is activated / <i>turn button clockwise to reset emergency stop, see p. 9</i>
	Battery is empty / <i>change to a new battery or recharge battery, see page 10</i>
	The control electronics of the lifter is overheated / <i>Leave lifter to cool down, see page 10</i>
	The lifter is overloaded / <i>make sure the load does not exceed 150 kg, see page 9</i>
	The hand control cable is unplugged / <i>reconnect plug</i>
Battery does not recharge	Hand control has failed / <i>replace hand control / contact local representative for service</i>
	Defective control electronics / <i>contact local representative for service</i>
	Faulty battery / <i>try another battery / replace battery</i>
	Faulty battery charger / <i>try another charger / contact local representative for service</i>

If you have access to more than one lifter, it may be helpful to change parts across lifters to help identify any faults. For instance, if you suspect the fault to be inside the hand control, exchange the hand control with a functional one from another similar lifter to see if the problem is fixed.

If you are not able to solve the fault or problems by yourself using this manual, please contact local authorised service representative. If you do not know whom to contact locally, please contact your dealer or Etac AS to get help.

Maintenance

Maintenance of the lifter consists of check before use, cleaning, inspection and service. Check the lifter according to the checklist before use on page 7, to reveal faults or errors. In regularly inspections of the lifter, which as a minimum should be monthly inspections and annual (periodic) inspections.

Cleaning



Detergents must be pH-neutral. Do not use solvents or strong liquids - this may damage surfaces on the lifter. For disinfection when needed; use isopropyl alcohol. Avoid abrasive cleaning products.

- Clean surfaces with a damp cloth using an appropriate detergent.
- Remove hair and pile from the castors and verify that the castors rotates without abnormal friction.
- Clean contact and hand control with spirit or similar to remove grease and dirt.
- Regular cleaning is recommended and should be implemented in the suitable cleaning routines.

Monthly inspection

Assemble the lifter before inspection.

- Check the lifter according to the checklist before use on page 7.
- Clean the lifter as described above.
- Verify that the contacts of the hand control and charger is firmly in place, and verify that the cables for the hand control, actuator and charger are intact.
- Run the lifter up and down to verify that it runs normally and without any abnormal noise.
- The lifter must be taken out of service immediately and marked "Out of order", or not taken into service, if faults and/or irregularities are discovered.

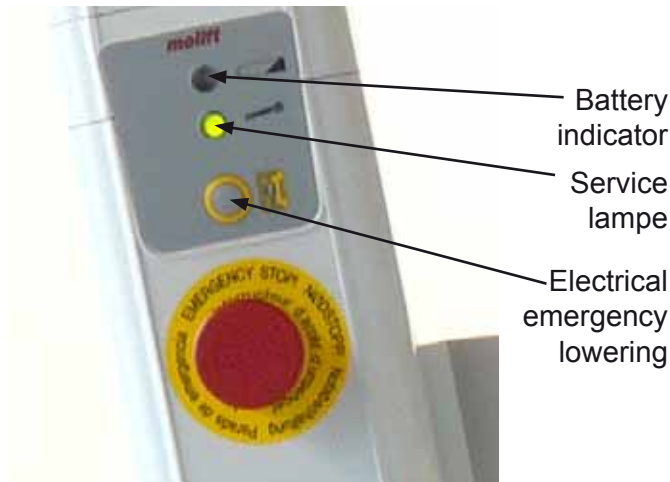
Periodic inspection

Etac Supply Gjøvik recommends periodic inspection once a year, alternatively more often if required by local regulations. Use the checklist for periodic inspection on page 18.

Inspection is to be performed by authorized personnel. The owner is responsible to ensure proper logging and written verification of each inspection.

Service

Molift Smart 150 has a LED on the battery holder indicating if the lifter needs service. The LED gives a green light when the lifter is ready for use.



The electronics logs how much the lifter is being used, and the load it is used with. After a given time of usage there will be given a signal that the lifter needs service to the service LED. The LED will first give a yellow light, then red. Take contact with your local service representative and order service. If there is a sound together with the light, it means the lifter needs service immediately.

Service lamp	Status
No light	Power save
Green	Ready for use
Yellow	Order service, lifter still works
Red	Perform service
Red + sound	Perform service immediately

Service consists of replacing the lifting motor and check/replacement of worn or damaged parts. Service and repair should be performed by authorized personnel only.

Fill in and sign a copy of the checklist on next page. The owner is responsible to ensure proper logging and written verification of each service or repair.

A list of spare parts is available on request.

Checklist for periodic inspection of Molift Smart 150
Revision F – 06/2009

COMPULSORY SAFETY CHECK (annual):

OK	Fault	Corrected	Visual inspection
			Whole lifter checked for damage, cracks and deformation and found to be in good order. (Especially suspension, lifting arm, lifting motor, wheels and all cables).
			Lifter has been correctly assembled and no parts are missing. (Especially column lock, column attachment and suspension).
			All labels are present, without damage and readable
			Accessories have been checked. See separate form for sling. Battery charger is an accessory. List the accessories checked:
			Function checks
			Emergency stop and hand control have been checked and are in working order.
			The lifter has been rolled over the floor (preferably under load) and runs easily and steadily.
			Leg extender mechanism functions correctly (stops in correct positions).
			The lifter has been fully raised and lowered (preferably under load) and moves evenly, without noise and the lifting motor shows no runout.
			Servicing required
			Servicing unnecessary because the servicing lamp is on green and the lifter is under 5 years old.

Completed	Compulsory in case of faults under one of the above points:
	The lifter has been removed from service and clearly marked "OUT OF ORDER".
	Certified personnel have been summoned to carry out repairs and servicing. Name /Tel./ Fax:

Completed	Compulsory where lifter has been checked and approved:
	The lifter has passed the safety check and been affixed with the Molift safety check label, duly dated and signed.
	The ticked and signed checklist has been passed to the client.

Comments on faults and repairs:

.....

.....

.....

.....

.....

Lifter serial no.: Other ID. no. (if any):

Client:

Inspection carried out by: (Block capitals) from

Molift certification no. (if any) of inspector/repairer:

The equipment has been tested and is in full working order Yes No

Place: Date: Signature:



DECLARATION OF CONFORMITY

molift[®]
by Etac

Etac AS, Etac Supply Gjøvik
Hadelandsveien 2
2816 Gjøvik
NORWAY
Telephone: + 47 4000 1004

hereby declare that:

Molift SMART 150 patient lifter
and that the accessoires used only together with this product

are in conformity with:

- The Council Directive concerning medical devices 93/42/EEC
and according to this classified as **medical equipment class 1**
Expiration date : 30th May 2017

Molift SMART is manufactured in conformity with the following national or international standards that also might implement a harmonised standard:

- ISO10535:2006 Hoists for the transfer of disabled persons - Requirements and test methods
 - ISO 14971:2007 Medical equipment - Risk analysis

Notified body:

Danish Technological Institute, Wood Technology
Gregersensvej 3
DK-2630 Taastrup
Denmark
Tel: + 45 7220 2301

NEMKO AS
Gaustadalleen 30
N-0314 OSLO
Norway
Tel: + 47 2296 0342

Title: Site Manager
Name: Knut Martin Frøsaker
Company: Etac AS, Etac Supply Gjøvik

30.05.2012
Date


Signature

taylordolman

tel: 0845 838 0600

email: info@taylordolman.com

www.taylordolman.com

molift[®]

by Etac